



INSTALLATION INSTRUCTIONS: THE FREESTANDING CAT FENCE SYSTEM

Scan to review our
installation video:



INCLUDED PARTS:

- | | | |
|--|---|--|
| (8) 86" Posts (1-3/8" diameter) with Post Caps | (1) 7.5ft x 100ft Heavy Duty Poly Mesh Fence Roll | (4) Post to Wall Straps |
| (8) Galvanized Ground Sleeves | (1) 24in x 100ft Welded Wire Mesh Fence Roll | (2) Arm to Wall Straps |
| (16) Self-Tapping Screws | (2) Boxes of (30) 12" Galvanized Ground Stakes | (1) Hex Wrench (for set screws) |
| (8) Spring-Loaded Arms | (4) Bags of (100) Standard Zip Ties | (1) Driving Cap (for ground sleeves) |
| (8) Post to Arm Couplers | (2) Bags of (100) Heavy-Duty Zip Ties | (1) Driver Bit (for self-tapping screws) |
| (16) Set Screws | | |

Please note: The components listed above are for a 100 ft kit. If you ordered more or less than 100 ft, your components may vary.

IMPORTANT:



It is strongly recommended that you review the installation video by scanning the QR code in the upper right or visiting our website at PurrfectFence.com/FS before starting your installation for the best results!

1 LAYOUT YOUR ENCLOSURE

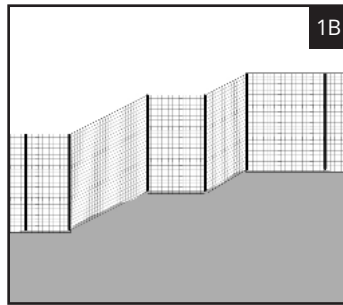
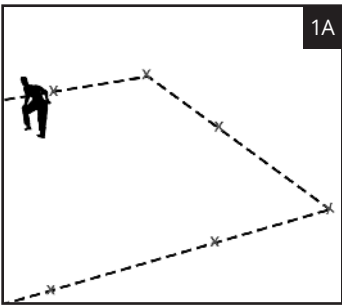

Layout Twice, Set Up Once

- 1A.** Plan your layout by measuring side lengths and marking the location of each post. Post spacing should be no more than 14' apart (12-14' is ideal).
- 1B.** Posts must be located at all points where the ground slope is more than gradual. The top of the fence line should run parallel to the ground. Additional posts are available for purchase when needed.

2 SET POSTS

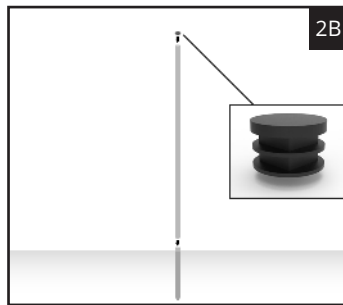
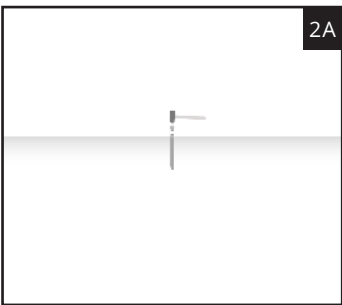

2A. Use a heavy hammer and the included drive cap to drive the ground sleeves into the ground at your post locations leaving 1 1/2" of the sleeve exposed at the top.

2B. Insert post caps into the top end of the post. Insert posts inside the ground sleeves.

2C. Secure posts to ground sleeves with included self-tapping screws. One screw on each side of the ground sleeve will prevent the post from spinning.

2D. All posts must be vertically aligned. Slightly bend posts if needed to adjust.

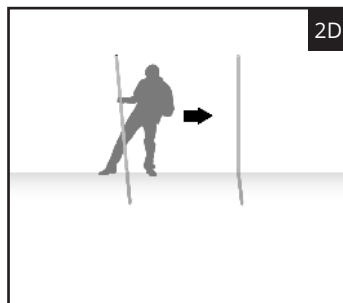
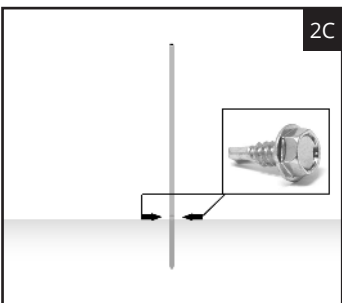



3 ATTACH ARMS TO POSTS

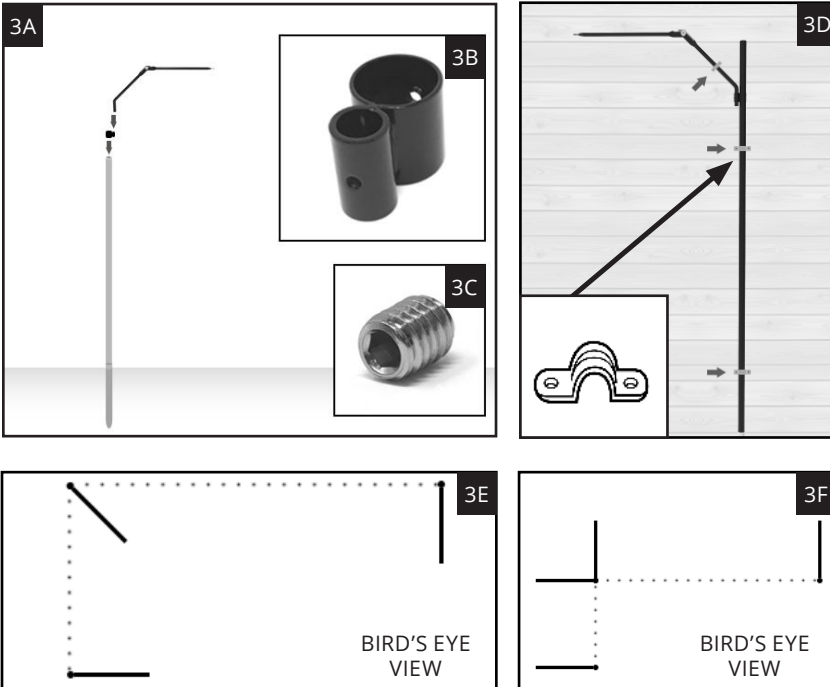

Using the Post to Arm Coupler

- 3A.** Slide the post to arm coupler (**3B**) over the top of the post and secure with a set screw (**3C**) using supplied hex wrench. Next, insert the spring-loaded arm into the opposite side of the coupler and secure with a set screw. Arm height is adjustable by loosening the set screw and moving the post to arm coupler up or down to desired height, then retightening the set screw. Distance from the ground to the tip of the arm should be a minimum 6 feet. Included components allow for a height of up to 7 feet. Taller is always better when possible.
- 3D.** Where posts connect to homes, sheds, barns, etc. use provided straps (version for posts and a version for arms provided) to hold the post securely against the structure. Ground sleeves may not be able to use due to the presence of the structure's foundation.
- 3E.** In corners, the arm should be positioned to point at a 45 degree angle (or split the corner for any angle between 90 and 180 degrees).
- 3F.** For outside corners, one post with 2 arms, and 2 post to arm couplers is needed. The arms should be pointed inline with the fence leading up to the corner. Applies for any angle between 180 and 270 degrees.

4 ATTACH UPPER POLY MESH TO ARMS / POSTS

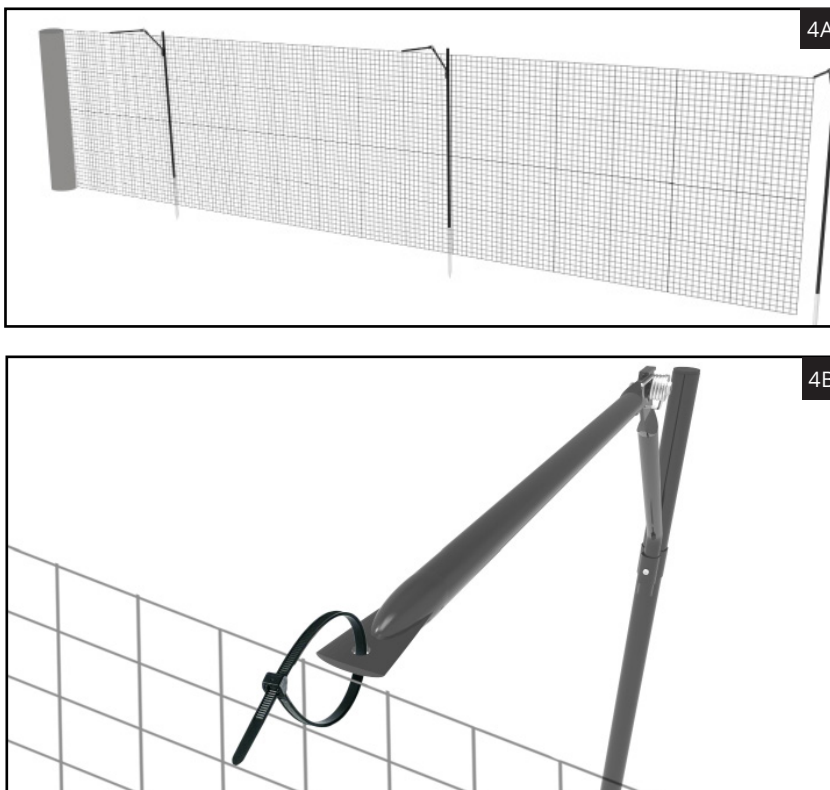

- 4A.** Unroll the mesh fence then lift the top edge up to the tip of the arm to secure with a standard zip tie.
- 4B.** Thread the zip tie through the hole at the tip of the arm and through the poly mesh fencing. Tighten the zip tie and cut off the excess tab. Repeat for each arm along the side. Do not try to pull the mesh overly tight between arms / posts.

Note: The upper poly mesh will go on the bottom side of the arm.



4 ATTACH UPPER POLY MESH TO ARMS / POSTS (CONTINUED)

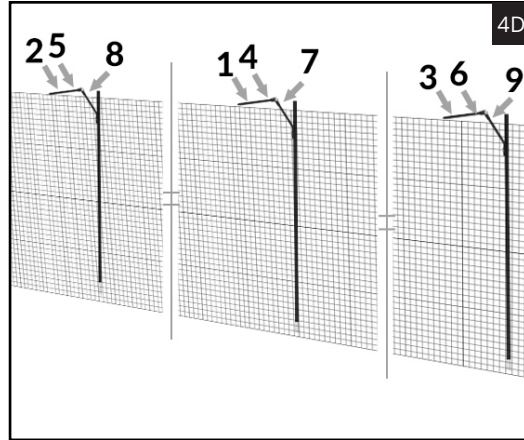
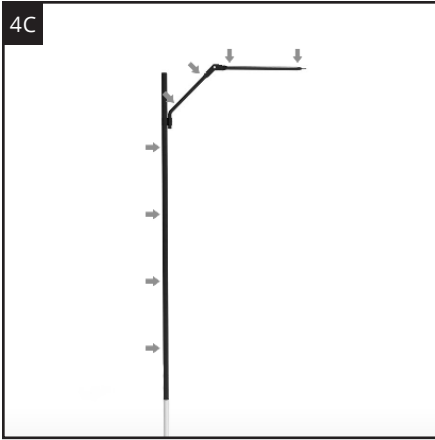

4C. Poly mesh will be secured to the post and arm at the points shown with heavy-duty zip ties.

4D. Attach mesh in groups of 3 when possible. After completing step **4A**, start with the middle post in the span and work from side to side in the order as shown in the diagram for best results. Continue this rotation down the span of the post.

Note: When attaching the mesh to the posts, use more ties at the end and corner posts of your enclosure.

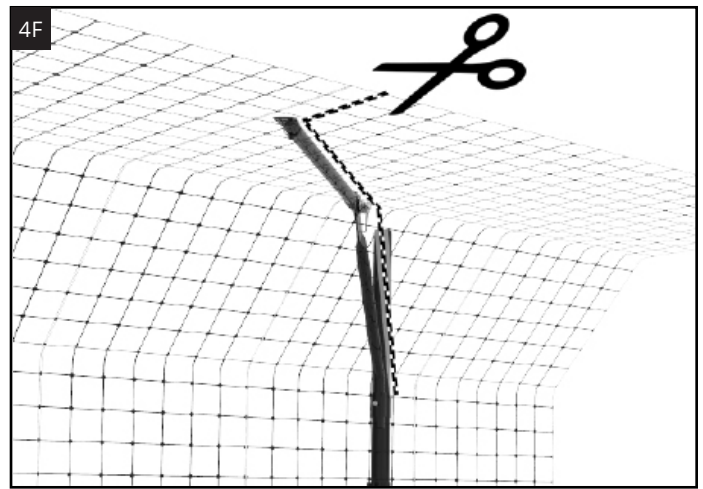
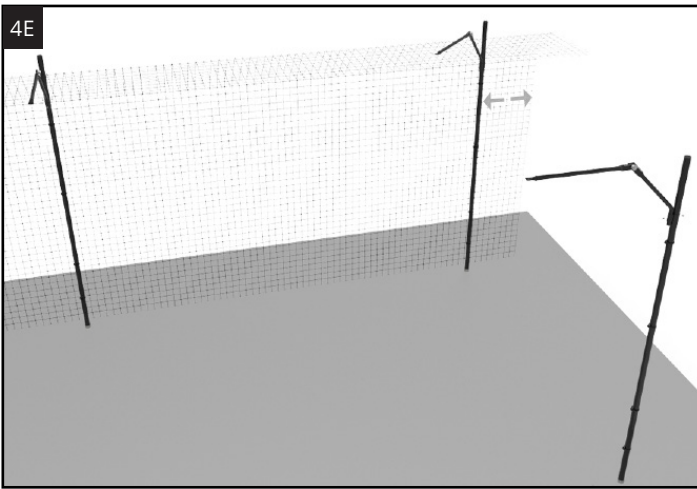

4E. Run the mesh fencing past the corner at least 4 inches before securing with zip ties.

4F. Once your corner post and arm has the mesh secured, you can trim away excess mesh along the edge of the arm and post in the pattern shown. Please consult steps **4H-4K** for more information about corners.

4G. Starting with a new span of poly mesh, overlap it 4 inches past the corner post from the opposite direction before securing the mesh to the tip of the arm on the corner. Then repeat the trimming in step **4F** once the mesh is secure to the corner post and the next post in the group you are installing the poly mesh fencing on.

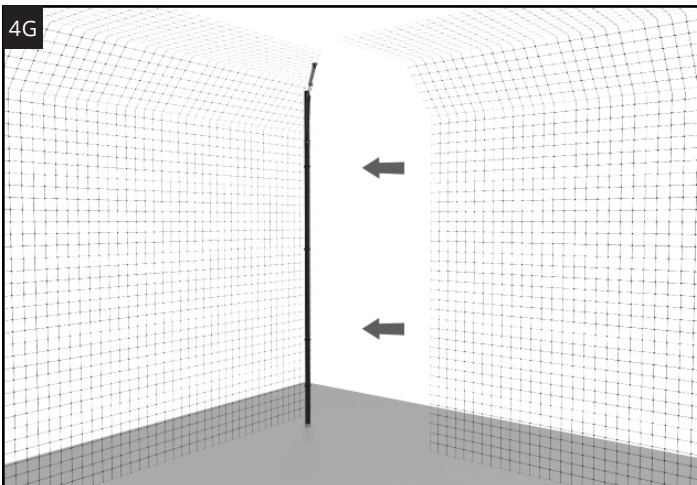

Repeat **Section 4** as necessary until all sides of the enclosure are complete.

Note: There will be a gap between the ground and the bottom edge of the poly mesh fencing once fully secured. This is intentional and the gap will be sealed in the next step.

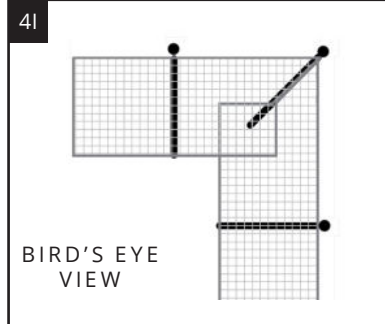
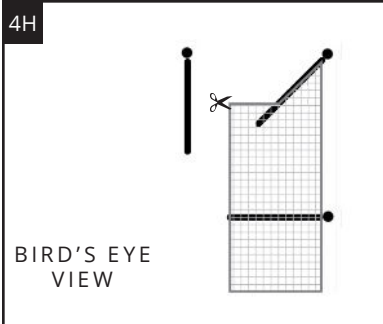

Inside Corners

4H. At corners the arms are angled relative to the rest of the arms in the sections which makes them "shorter." To adjust for this, attach the fence 4 squares in from the edge of the fence at the tip of the arm.

4I. Run the fence slightly past the corner post and cut the mesh fencing off the roll.

Note: This applies for any angle between 90 and 180 degrees. Corners less than 90-degrees should be handled with two posts/arms that "cut off" the angle. Please contact Purrfect Fence for more information.

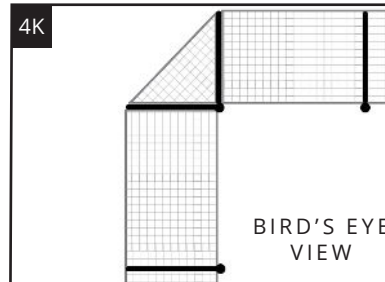
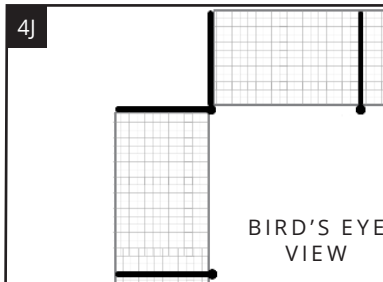

Outside Corners

4J. As shown in section 3F, outside corners require a special configuration. Each section of fence leading up to the corner must be cut at the arm leaving a gap in the corner.

4K. A separate piece of mesh is required for the outside corner between the arms.

5 ATTACH CHEW / DIG GUARD (WELDED WIRE)

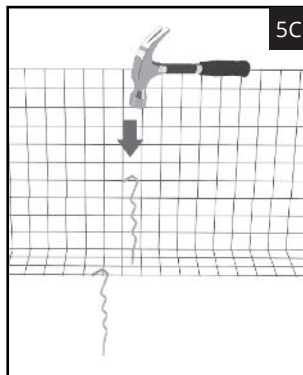
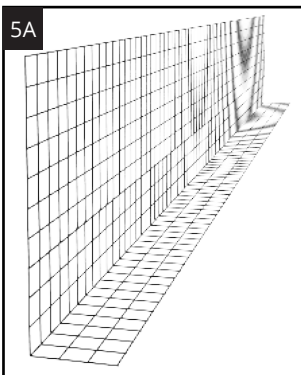

5A. Unroll the welded wire chew/dig guard to the length needed for the side. Form the mesh into a 90-degree angle "L" shape. Minimum of 2 squares of welded wire should be against the ground. The remainder will run vertically up the fence.

5B. Use standard zip ties to connect the top of the welded wire chew/dig guard to the bottom of the upper poly mesh fencing. It is recommended that you secure the fence "every other square." There should be a minimum of 1 square overlap of the mesh fencing and welded wire at the top. Excess mesh can be trimmed away or secured with zip ties once installed.

5C. Use a hammer to drive the provided 12" galvanized ground stakes into the ground ensuring that the hooked tip holds the wire mesh securely to the ground. It is best if the stake is positioned to hold the wire mesh where two strands of wire intersect. Stakes can be spaced up to 2 feet apart (left to right) and can be alternated from front to back for added security.

Note: For additional security against digging and chewing animals outside your enclosure, you may choose to install the chew/dig guard on the outside of the enclosure instead of the standard inside configuration as shown.

